

# INSTRUCTION MANUAL

# TINTORETRIEVER PRESSURE COOKER

For Nucleic Acid & Epitope Retrieval

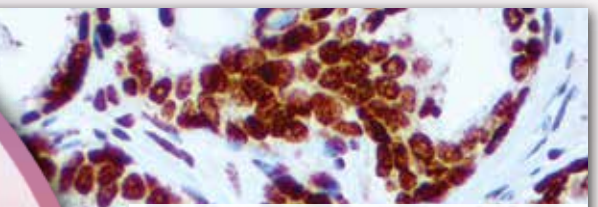

Immunohistochemistry



Fluorescent *In-Situ* Hybridization

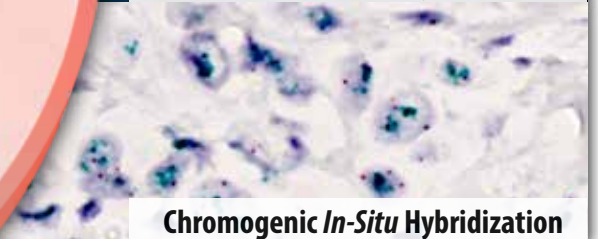

Chromogenic *In-Situ* Hybridization

## Index

Topic	Page
Description & Features	Page 2
Main Technical Parameters	Page 3
Safety Requirements	Page 4
Parts & Features	Page 5
Installation	Page 6
Operating Procedures	Page 7
Cleaning & Storage	Page 9
Temperature Settings	Page 10
Applications for IHC	Page 11
Troubleshooting & Contact info	Page 12
Quality Control Certificate	Page 13



Figure 1 - TintoRetriever system with slide racks and reagent holders.

### 1. DESCRIPTION & FEATURES

Most formalin-fixed tissues, especially those fixed with formalin and embedded in paraffin, require an epitope retrieval step prior to any immunochemical staining. The epitope retrieval step breaks some of the methylene bridges that cross-link proteins in formalin-fixed tissue and allows antibodies, probes or other immunochemicals to bind to unmasked epitopes or nucleic acids.

Heat-induced epitope retrieval (HEIR) and nucleic acid retrieval steps are most often performed using a conventional pressure cooker or a microwave oven. The Bio SB TintoRetriever is a precision-controlled heat source capable of maintaining a constant and reliable temperature while minimizing the potential for evaporation of the working solution under HIER procedure conditions.

The TintoRetriever Pressure cooker is recommended for use in Immunohistochemistry (IHC), Immunocytochemistry (ICC), Immunofluorescence (IF) and In-Situ Hybridization (ISH) protocols, and can be easily integrated into a clinical or research laboratory.

#### TintoRetriever Applications (Pictured on Cover)

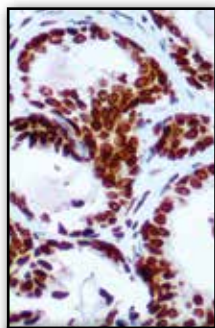

IHC  
 p40 RMab  
 BSB 2072

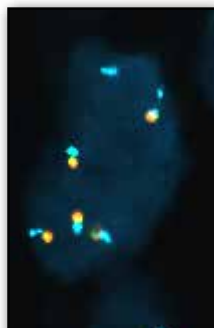

FISH  
 ALK/EML4 TriCheck  
 Z-2117-200

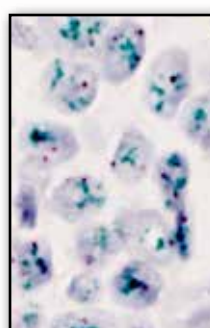

CISH  
 HER2/CEN 17  
 3022-40

- Rapid Heat Retrieval
- Multiple Temperature Settings
- Use in IHC, ICC, IF and & ISH Applications
- Low Reagent Use
- Holds 96 Slides Per Run
- Cost Effective HIER Solution

## 2. MAIN TECHNICAL PARAMETERS

- Power Requirements: AC110V, 60Hz, 1000W
- Dimensions: 320mm x 320mm x 340mm (W x D x H)
- Packaged Dimensions: (330mm x 330mm x 360mm) (W x D x H)
- Weight: 12.6 lb (5.7 Kg)
- Operational Temperature: 10 °C - 35 °C
- Operational Humidity: 85%
- Chamber Working Temperature: 100 °C - 121 °C (+/- 1- °C)
- Chamber Working Pressure: 10 - 15 PSI (103 kPA, 1.03 bar, 1 kg/cm<sup>2</sup>)

### NOTE:

TintoRetriever Pressure Cooker is intended to be run with AC110V, 60Hz,1000W.

If there is a need to operate this instrument at AC 220V, Bio SB recommends using a transformer with the following specifications.

Output: 110Volts and a minimum of 1000Watts



Figure 2 - Recommended transformer for use in countries with 220V standard electricity.

### 3. SAFETY REQUIREMENTS:

**CAUTION:** Read the user manual fully before use and pay particular attention to sections containing this symbol. Please carefully read user manual before installation, operation, maintenance and repairing to avoid personal injury and damage to the Instrument.



- 3.1 Do not immerse electrical cord, plugs or main cooker body into water or other liquids to avoid electrical shock and/or fire hazard.
- 3.2. Do not touch hot surfaces of the pressure cooker. Use handles only.
- 3.3. Operate the pressure cooker only with properly closed lid.
- 3.4. Do not fill working chamber with more than recommended volume of water.
- 3.5. Never attempt to open the lid while the unit is operating. Wait until the unit is switched off and pressure has been completely released. If the lid is difficult to rotate, this indicates that the working chamber still has excess pressure.
- 3.6. Never move the pressure cooker while operating it.
- 3.7. Exercise care when releasing excess pressure from the cooker; improper technique may result in scalding or injury.
- 3.8. Unplug from outlet when not in use or when cleaning/servicing.
- 3.9. Do not use under hanging shelves, cabinets etc or damage may occur.
- 3.10. **Always check the pressure limit valve for possible clogging before each run.**

## TintoRetriever Components

Number	Component
1	Pressure Limit Valve
2	Red Pressure Indicator
3	Push Rod
4	Sealing Ring
5	Working Chamber
6	Condensation Collector
7	Handle
8	Main Body
9	Heating Plate
10	Base
11	Power Cord
12	Lid Handle
13	Lid
14	Sealing Ring Supporting Cover
15	Rubber Grommet
16	Upper Ring
17	Control Panel
18	Trivet

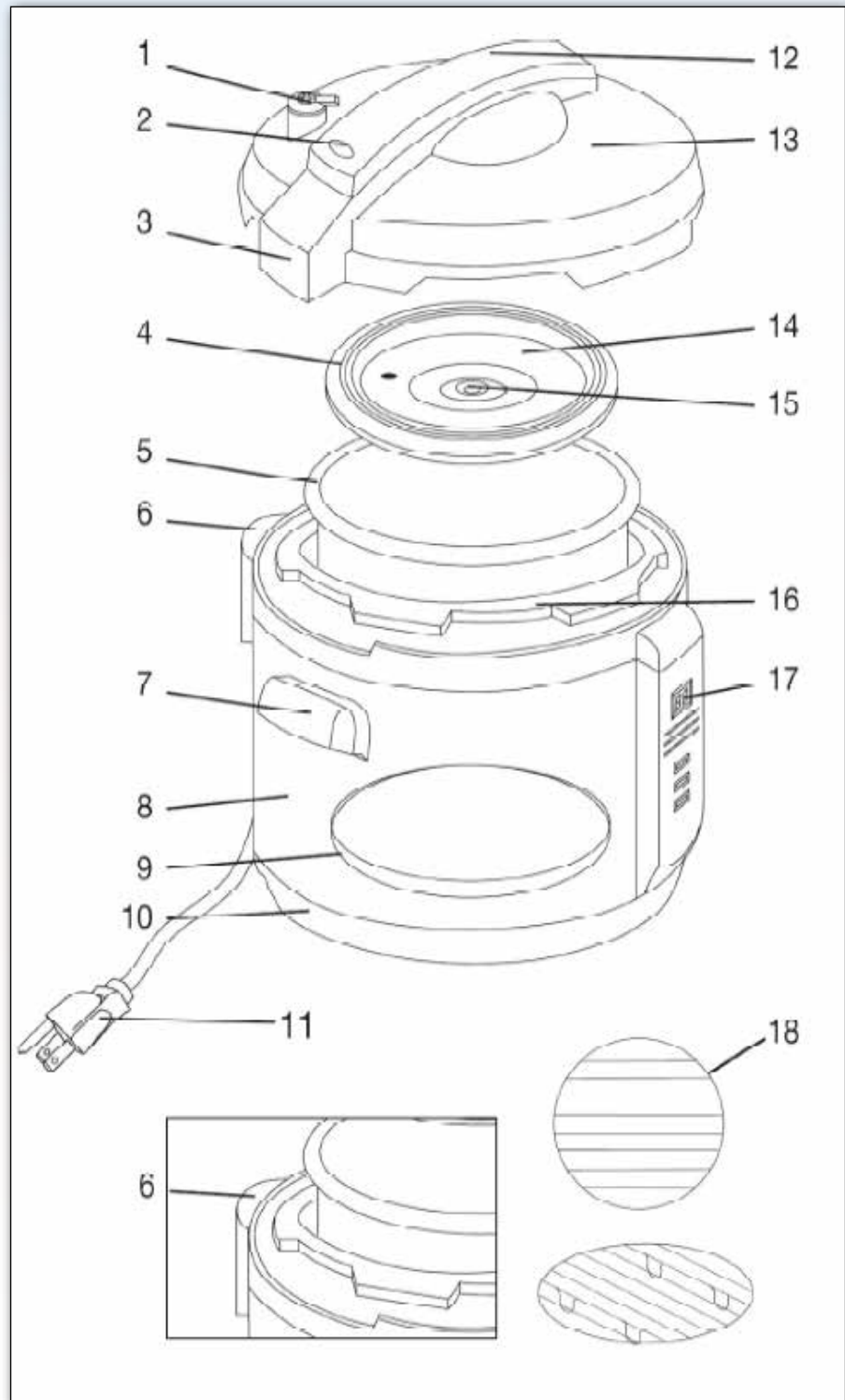

Figure 3 - TintoRetriever Parts



## 5. INSTALLATION:

Refer to Bio SB TintoRetriever Pressure Cooker Unboxing and Installation video:  
<http://www.biosb.com/technical-resources/videos/>

**5.1.** Remove TintoRetriever Pressure Cooker from packaging material and inspect for any damage. Please follow important unpacking instructions provided with the shipment and be sure all parts have been included before discarding any packaging material. If any signs of mechanical damage to the Digital Pressure Cooker have been observed, do not use it and contact Bio SB (see page 12 for contact details).

**5.2.** Thoroughly clean all parts with a towel/rug and place the Digital Pressure Cooker on a clean, flat surface.

**5.3.** Place the condensation collector in the rear of the main cooker body until it clicks into place as shown below:

**NOTE:** Even though pressure limit valve will have a loose fit, it is safely secured.

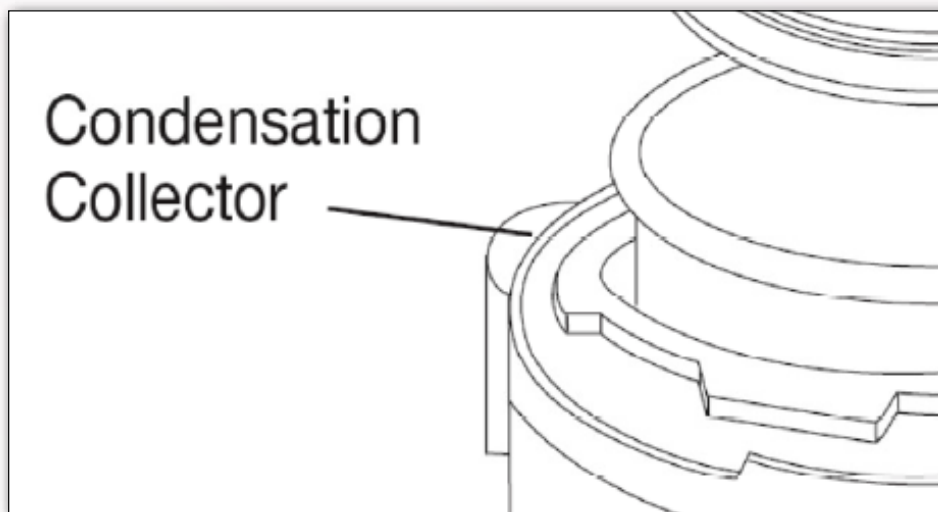

Figure 4 - Condensation Collector Placement

Place the pressure limit valve on the lid as shown below:

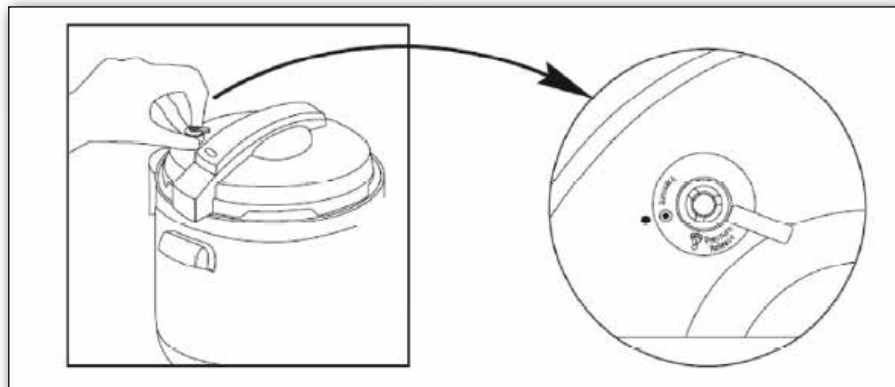

Figure 5 - Setting Instrument to Pressure setting

## 6. OPERATION PROCEDURES:

- 6.1.** Place clean and dry working chamber and dry the main body. Make sure that no water or any other liquid is present inside the main body. Any liquid inside the main body may cause a malfunction with permanent damage, as well as cause a **SERIOUS HEALTH AND/OR FIRE HAZARD** ⚠️.
- 6.2.** Position the trivet the inside working chamber (legs down) and pour approximately 500 ml to 1000 ml of water into the working chamber to barely cover the trivet's surface.
- 6.3.** Prepare the reagent holder (BSB 7009) with slides in slide rack (BSB 7010) and gently fill the container with working concentration of HIER solution. We recommend Bio SB ImmunoDNA Retriever with Citrate (BSB0023, BSB0020, BSB0021, BSB0022) or with ImmunoDNA Retriever EDTA (BSB 0033, BSB 0030, BSB 0031, BSB 0032).
- 6.4.** Place the prepared container inside the working chamber on top of the trivet. Make sure that the bottom of the container makes good contact with water in the working chamber.
- 6.5.** Place and secure the lid onto the cooker's main body. This is done by putting the lid into place atop the cooking chamber with the red pressure valve on the left and turning the lid counter clockwise to secure in place.
- 6.6.** Position the pressure limit valve into the "pressure" position (see below figure).

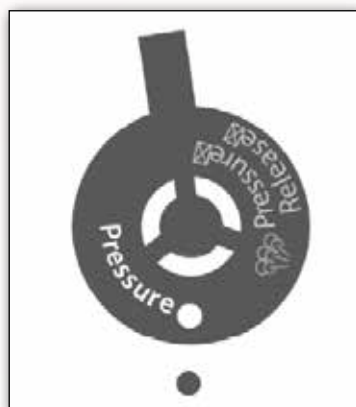

Figure 6 - Pressure cooker in pressure mode

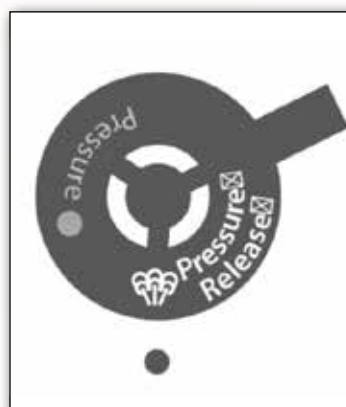

Figure 7 - Pressure cooker in pressure release mode

## 6. OPERATION PROCEDURES (Continued):

6.7. Plug the power cord into an outlet.

6.8. Press the MENU button on the control panel until the desired indicator light is lit. For recommended settings for proper epitope or nucleic acid retrieval refer to page 11.

6.9. Press the TIME button until the desired time is lit. Bio SB recommends a 15 minute time setting for proper epitope or nucleic acid retrieval (see page 11).

If needed, press the START/CANCEL button twice to reset timer and then set new desired time.

**NOTE:** Timer will count time accurately only if used with 60 Hz electrical supply.

6.10. Press the START/CANCEL button to start the procedure. The red pressure light will flash. As the pressure and temperature increases, the red pressure valve on top of the lid will rise and stay in place until the pressure is eventually released. Confirm that the red pressure valver has risen to the top a few minutes after starting the unit, typically 5 to 10 minutes fter cycle start (see note 2).

**NOTE 1:** If the red pressure valve does not rise to the top it will prevent sufficient pressure build-up within the chamber and could cause overcooking of the samples.

**NOTE 2:** The timer will start counting down only after unit reaches the preset temperature and pressure.

6.11. At the end of the set time, the unit will beep and automatically switch to the “keep warm” setting until the START/CANCEL button is pressed again (see 6.8).

**NOTE:** Do not keep slides under “keep warm” conditions for an extended amount of time as it will affect performance of your nucleic acid/epitope retrieval procedure.

6.12. Position the pressure limit valve into the “release” position.

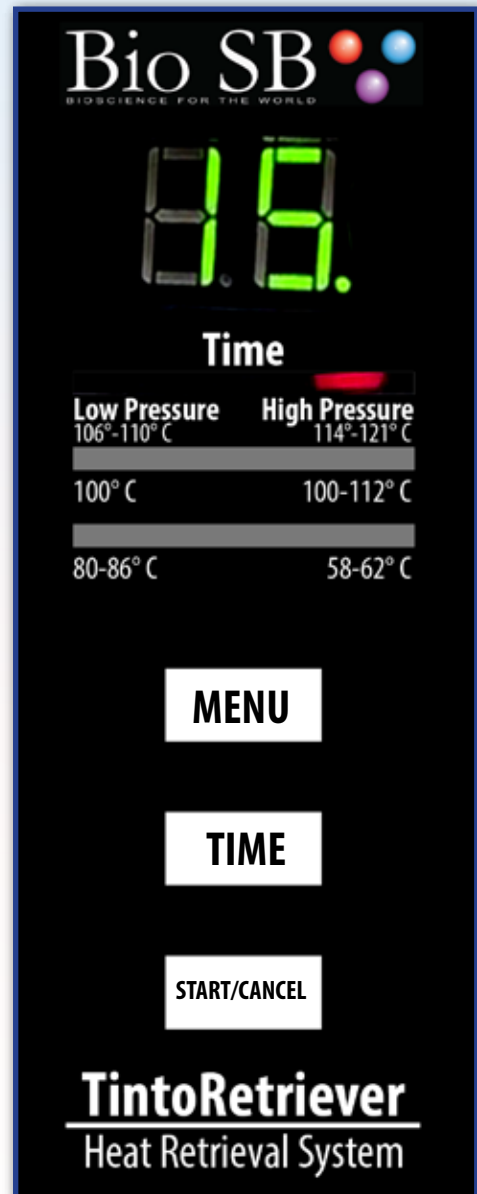

Figure 8 - Front Panel of TintoRetriever



Figure 9 - Valve in “Pressure Release” position





**CAUTION!:** Steam coming out of pressure limit valve can cause a **SERIOUS HEALTH HAZARD**. Avoid scalding by wearing suitable protective clothing and exercising extra caution.

**6.13.** Confirm that the red pressure valve dropped and remove the lid by turning it clockwise. Open and Lift the working chamber.

**6.14.** Remove the container with the slides from the working chamber. Allow slides to cool for 15-20 minutes. Proceed with slide treatment as recommended by your protocol.



**CAUTION!:** Be aware that container and inner parts of cooker will be extremely hot. Avoid **SERIOUS HEALTH HAZARD** (scalding or burns) by wearing suitable protective clothing and exercising extra care.

## **7. CLEANING AND STORAGE**

**7.1.** Unplug from outlet when not in use or when cleaning/servicing.

**7.2.** Wait until the working chamber, the water inside chamber and the trivet have been cooled to room temperature.

**7.3.** Remove the working chamber from cooker and remove the trivet from the working chamber.

**7.4.** Inspect the main body and remove any water/residue from inside or outside with a clean dry paper towel/rug. Do not immerse the main body in water or pour water onto it.

**7.5.** Dispose the water from the working chamber and dry the working chamber and trivet with clean paper towel/rug. Never use harsh chemicals or scouring pads.

**7.6.** If needed, disconnect the condensation collector, remove any water, and dry it with clean paper towel/rug.

**7.7.** If needed, dry the lid and the gaskets with a clean towel/rug. Never use harsh chemicals or scouring pads.

**7.8.** Connect the condensation collector back to the main body, place the working chamber back inside the main body, place the trivet inside the instrument and place lid on top of the main body. Protect from heat, water, snow, mechanical and electromagnetic shock.

**NOTE:** Do not lock the lid to allow any residual moisture to escape internal parts of cooker.

## 8. TINTORETRIEVER TEMPERATURE SETTINGS

### High Pressure

Temperature (°C)
Pressure 114°-121°C

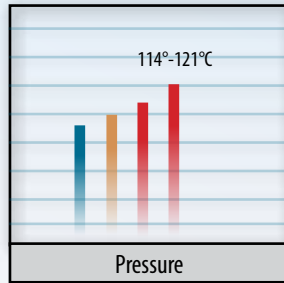

### Low Pressure

Temperature (°C)
Pressure 106°-110°C

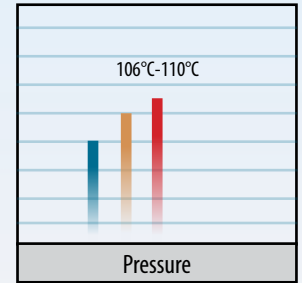

### 100-112°C

Temperature (°C)	
Pressure Release 100°C	Pressure 106°-112°C

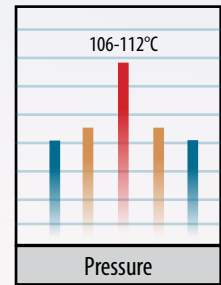
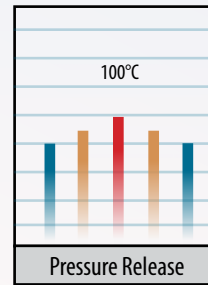

### 100°C

Temperature (°C)
Pressure Release 100°C

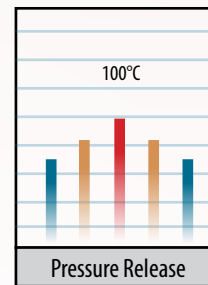

### 80-86°C

Temperature (°C)	
Pressure Release 80-86°C	Pressure 80-86°C

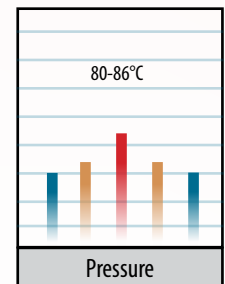
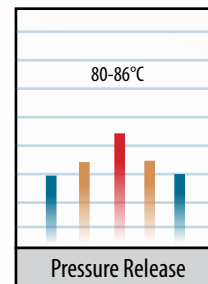

### 58-62°C

Temperature (°C)	
Pressure Release 58-62°C	Pressure 58°-62°C

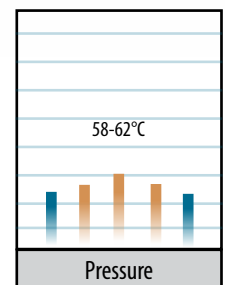
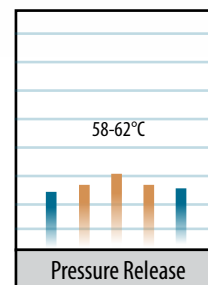

Heating devices like autoclaves or pressure cookers work with feedback sensor mechanisms that work within a certain range. For example, the high pressure setting provides a temperature range of 114-121 °C, where the instrument heats up to 121 °C then turns the heating off until the temperature reaches 114 °C, when the heating mechanism is again activated to heat up to 121 °C. This process is repeated throughout the cycle.

## 9. TINTORETRIEVER IN THE LABORATORY

The TintoRetriever is a rapid epitope and nucleic acid retrieval system which can be used in a variety of applications in the modern pathology lab.

The Bio SB TintoRetriever comes pre-programmed with 6 temperature settings that can be used for deparaffinization, epitope retrieval, or nucleic acid retrieval (ISH).

This section will focus on tips and recommended settings for the TintoRetriever in a clinical or research setting.

### IHC Epitope Retrieval & ISH Nucleic Acid Retrieval 1

For formalin-fixed paraffin-embedded (FFPE) tissue sections, the High Pressure setting with a time of 15 minutes is recommended for thorough heat permeabilization of tissue. We recommend using Bio SB Immuno/DNA Retriever with Citrate (BSB 0020 - BSB 0023) or Immuno/DNA Retriever with EDTA (BSB 0030 - BSB 0033) for IHC/ISH protocols.

#### Tissues prone to detachment

Should tissues detach after using the “High Pressure” setting, it is recommended that tissues are mounted using Bio SB Hydrophilic Plus Slides (BSB 7028). Hydrophilic Plus Slides prevent tissue detachment while promoting reagent dispersion.

### Tissue Microarrays 2

Tissue Microarrays (or TMA's) typically need gentler epitope retrieval methods than those used with whole tissue sections. At Bio SB, our Normal, Cancer and Cell Line Microarrays undergo heat-induced epitope or nucleic acid retrieval using the Low Pressure (106 C-110 C) or High Pressure (114 C-121 C) options. Additionally, the Bio SB TintoRetriever PT module has gentler epitope retrieval settings (BSB 7030), and may be ideal for labs that utilize TMA's.

### TintoDeparaffinator Citrate and EDTA 1 2

The TintoDeparaffinator Citrate and TintoDeparaffinator EDTA (BSB 0175 - BSB 0178) are safe, efficient and economical alternatives to traditional deparaffinization. These solvent-free products reduce exposure to toxic solvents like xylenes, toluene and alcohols when handling FFPE tissues for molecular pathology. These solutions are recommended to be used at Low Pressure (106 C - 110C) or High Pressure (114 C- 121 C) for 15 min.

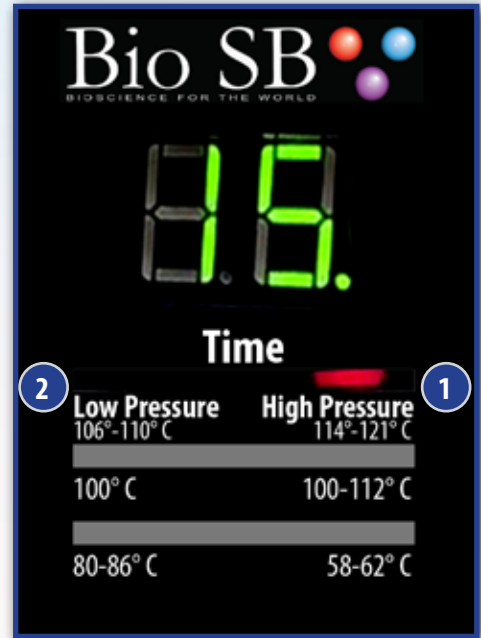

Figure 10 - Pre-programmed temperature settings



Figure 11 - Hydrophilic Plus Slides  
BSB 7028

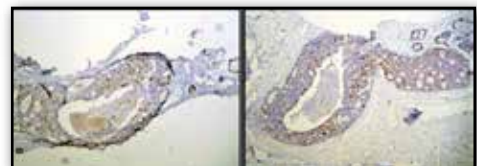

Figure 12 -Tissue Detachment on a Hydrophobic Slide (Left) vs. Hydrophilic Slide (Right)

## 8. TROUBLESHOOTING

<b>Problem</b>	<b>Cause</b>	<b>Solution</b>
Lid does not lock	The ring is not properly installed	Reinstall ring
	Red pressure valve is seized by push rod	Push rod down
Can't open lid after steam exhaust	Red pressure valve is up	Press red valve down or wait for temperature to drop
Steam escapes from the rim of lid	No sealing ring was installed	Install the sealing ring
	Sealing ring worn out/dirty	Clean/replace ring
	Lid is not locked	Rotate and lock lid
Steam escapes from red pressure valve	Sealing ring on valve is worn out	Replace sealing ring
	Dirty red pressure valve	Clean valve
Red pressure valve will not rise	Pressure limit valve is not placed properly	Set the pressure limit valve to "Pressure" setting
	Not enough water in the working chamber	Add sufficient amount of water to cover trivet
Steam escaping from rim of lid while pressure limit valve is in "Pressure" position	Lid not secured and in lock position	Re secure lid and twist until locked
Serious malfunction	Unknown	Stop operation of unit and call customer support
Pressure valve not sealing	Pressure valve needs lubrication	See page 13...

## PROBLEM: PRESSURE VALVE NOT SEALING

### SOLUTION: LUBRICATING THE PRESSURE COOKER VALVE (You do not need tools for this)

1. Remove lid from pressure cooker and flip it upside down.
2. Remove inside lid.



3. Remove Plastic washer

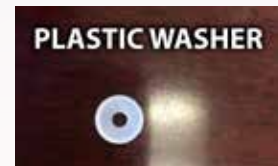

4. Push down on valve
5. Lubricate valve



6. Put lid back together

#### To contact Bio SB customer support

Phone: 1-800-561-1145  
Email: [technical@biosb.com](mailto:technical@biosb.com)

Hours of Operation: 9am - 5pm PST, Monday - Friday



## Guarantee and Warranty

When used in laboratory conditions and according to these working instructions, this product is guaranteed for ONE YEAR from shipping date against faulty materials or workmanship. For service or technical help, please contact our Technical Support (technical@biosb.com) or your local distributor.

This product is warranted to the original purchaser only to conform to the quantity and contents stated in this manual and outer labels. Bio SB Inc.'s obligation and the purchaser's exclusive remedy under this warranty is limited to replacement, at Bio SB Inc.'s expense, of any product which shall be defective in manufacture, and which shall be returned to Bio SB Inc., transportation prepaid, or at Bio SB Inc. option, refund of the purchase price. Claims for merchandise damaged in transit must be submitted to the carrier. This warranty shall not apply to any products which have been altered outside Bio SB Inc., nor shall it apply to any products which have been subjected to misuse or mishandling.

ALL OTHER WARRANTIES EXPRESSED, IMPLIED OR STATUTORY ARE HEREBY SPECIFICALLY EXCLUDED, INCLUDING BUT NOT LIMITED TO WARRANTIES OF MERCHANT ABILITY OR FITNESS FOR A PARTICULAR PURPOSE. Bio SB Inc.'s maximum liability is limited in all events to the price of the products sold by Bio SB Inc. IN NO EVENT SHALL BIO SB INC. BE LIABLE FOR ANY SPECIAL, INCIDENTAL OR CONSEQUENTIAL DAMAGES.

**Product Name:** *Bio SB TintoRetriever Pressure Cooker*

**Product Catalog Number:** *BSB 7008*

**Serial No.:** \_\_\_\_\_

**This product is tested and qualified for delivery.**

**Checked by:** \_\_\_\_\_

**Date:** \_\_\_\_\_

